

# Verifying *Bluetooth*<sup>™</sup> Baseband Signals Using Mixed-Signal Oscilloscopes

Application Note 1333-3

## Who Should Read This Application Note?

R&D engineers working on *Bluetooth*<sup>™</sup> applications. More specifically, designers of *Bluetooth* modules that bridge the RF and baseband technologies, and designers of *Bluetooth* wireless technology devices that integrate *Bluetooth* modules into their designs. This app note is a collaboration of Agilent and Texas Instruments' *Bluetooth* application engineering team and high-performance *Bluetooth* chipset. It highlights some key *Bluetooth* baseband measurements and specifies how they are performed using a mixed-signal oscilloscope. Concepts include verifying transmission and receipt of data packets, viewing the actual data values transmitted, quantifying system bottlenecks, and identifying logic errors. However, the app note is not meant to be a comprehensive examination of all *Bluetooth* measurements.

## Wireless Connectivity with *Bluetooth*

*Bluetooth* is a specification for a short-range wireless communication technology. It enables rapid ad hoc networking and will virtually eliminate the need for interconnecting cables between computing and telecommunications devices. *Bluetooth* is designed to operate as a personal area network with a transmission range of approximately 10 meters. The technology uses Frequency Hopping Spread Spectrum (FHSS) and offers robust operation in the high-interference unlicensed 2.4 to 2.4835 gigahertz frequency range of the Industrial, Scientific, and Medical (ISM) radio band which is unlicensed and globally available.

The *Bluetooth* specification is a de facto standard containing the information needed to ensure that diverse devices supporting the technology can communicate with each other worldwide. It includes a specification for components such as the radio, baseband, link manager, transport layer, and service discovery protocol. It also specifies interoperability protocols and procedures required for communication with the various types of *Bluetooth* applications. The *Bluetooth* standard is quickly gaining acceptance worldwide and it is estimated that hundreds of millions of products with *Bluetooth* technology will appear by the year 2002.

## *Bluetooth* Devices

When *Bluetooth* devices are brought within range, they will automatically seek each other out and form a piconet. Piconets consist of a Master device, such as a laptop computer, and Slave devices, for example a printer, PDA (personal digital assistant), overhead projector, digital camera, and another laptop computer. A Master device can actively communicate with up to seven Slave devices, and at the same time, more than two hundred Slaves can be registered in a non-communicating, power-saving mode. The area of control is defined as a piconet. A unique pseudo-random frequency-hopping sequence is established for each piconet, which prevents interference from other nearby piconets and *Bluetooth* devices. The Master device's clock is used to synchronize all other devices in the piconet, and the piconet is defined by its unique hopping sequence.



Agilent Technologies

## Bluetooth Host and Radio Unit

Figure 1 depicts a functional diagram of a *Bluetooth* device, consisting of the host device, transmitter, receiver, and the baseband. The host is a device such as a laptop computer, which runs the application that is sharing information.

The transmitter upconverts baseband information to the frequency-modulated carrier, and the receiver downconverts and demodulates the radio frequency signal. The type of modulation used in a *Bluetooth* system is 2-level Gaussian Frequency Shift Keying (GFSK), a type of Binary Frequency Shift Keying (2FSK) in which the modulated carrier shifts between two frequencies representing a logical one and logical zero respectively. The system uses two different frequencies for the 0 and 1 values of each bit. A base frequency and carrier deviation are used, where the sum of the two frequencies form a logical one, and the difference of the two frequencies form a logical zero. The receiver measures the deviation of the signal with respect to the reference frequency to determine which bit value was transmitted.

Due to the short period of time each value is present, system timing synchronization is critical for the receiver to determine when each bit is transmitted, and the deviation of the signal must fit within the band allocated to it which for *Bluetooth* is a 1 MHz window. Radio frequency test equipment such as spectrum analyzers and vector signal analyzers are useful for making spectrogram measurements and for testing phenomena such as carrier frequency drift, burst profile, and frequency modulation characteristics.

More information about these measurements can be found in “*Bluetooth™ RF Measurement Fundamentals*” Agilent Application Note 1333-1, Publication Number 5988-3760EN.

## Time Domain Signals

Much information has been published on performing high-frequency measurements of *Bluetooth* radio components. Equally important for the integration of a *Bluetooth* chipset is the verification and measurement of the kilohertz- and megahertz-ranged signals present in the digital baseband, the functional component of a *Bluetooth* device where incoming data from the radio component is slowed and signal processing occurs (see Figure 1).

Oscilloscopes and logic analyzers are the tools of choice for time-domain analysis of electrical signals. In its most simple operation, an oscilloscope measures the changes in electrical signals and displays a plot on screen of voltage versus time where the vertical (Y) axis represents voltage and the horizontal (X) axis represents time. The intensity of brightness of the display is often considered a third (Z) axis. Oscilloscopes are typically used for verifying waveform shapes, measuring voltages and frequencies, calculating signal transition times, detecting overshoot, ringing and other noise, and for general-purpose debugging of electrical system behavior.

Logic analyzers, like oscilloscopes, provide time-domain analysis of electrical signals. One major difference between logic analyzers and oscilloscopes is that logic analyzers use only a one-bit encoding of the signal value, storing only whether the signal value is high or low (above or below a threshold), while oscilloscopes record a byte or more of data to represent the signal value. Another contrast is the number of channels. While oscilloscopes typically contain two or four input channels, typical logic analyzers support dozens or even hundreds of input channels.

A mixed-signal oscilloscope combines all of the capabilities of a digitizing oscilloscope with some of the functionality of a logic analyzer. The result gives the user the ability to analyze analog characteristics of electrical signals while simultaneously viewing the logic timing interactions of many digital signals. Because of this, a mixed-signal oscilloscope can be an optimal tool and invaluable resource for debugging *Bluetooth* baseband circuitry at the system level.

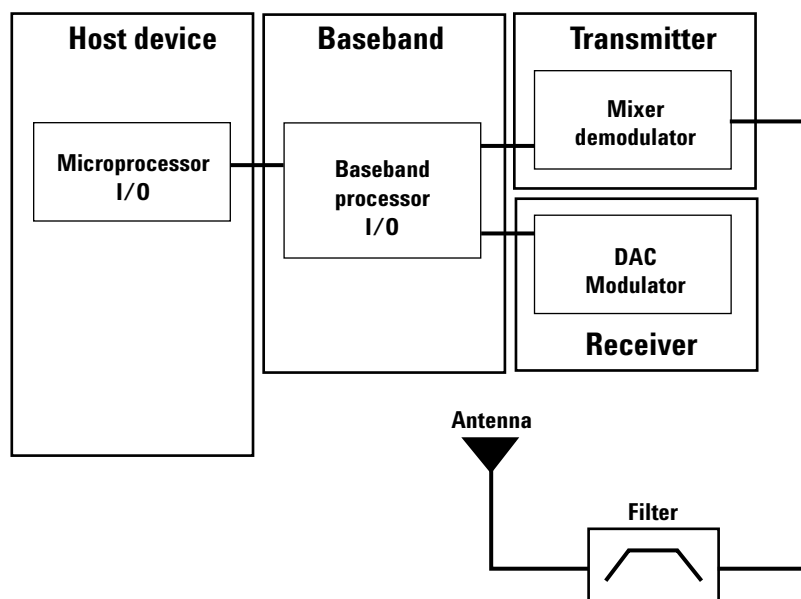

Figure 1: *Bluetooth* device functional blocks

## Verifying Transmit and Receive

All *Bluetooth* signals are transmitted and received through the RF portion of a *Bluetooth* device. Information is then transferred to the digital baseband for processing via the transmit and receive serial lines (see Figure 2).

An oscilloscope can be used to verify in real time the matching and delayed values of the transmit and receive lines. This starting point in circuit debugging allows an initial verification that communication between the devices is occurring.

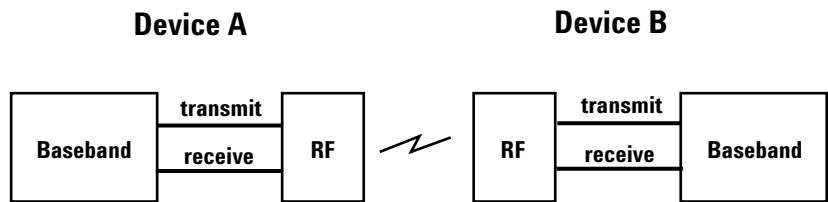

Figure 2: Transmit and receive lines

Figure 3 shows a single acquisition of the transmitted and received signals of one *Bluetooth* device. Captured at a slow sweep speed, the high-level interaction between the transmit and receive signal lines is displayed.

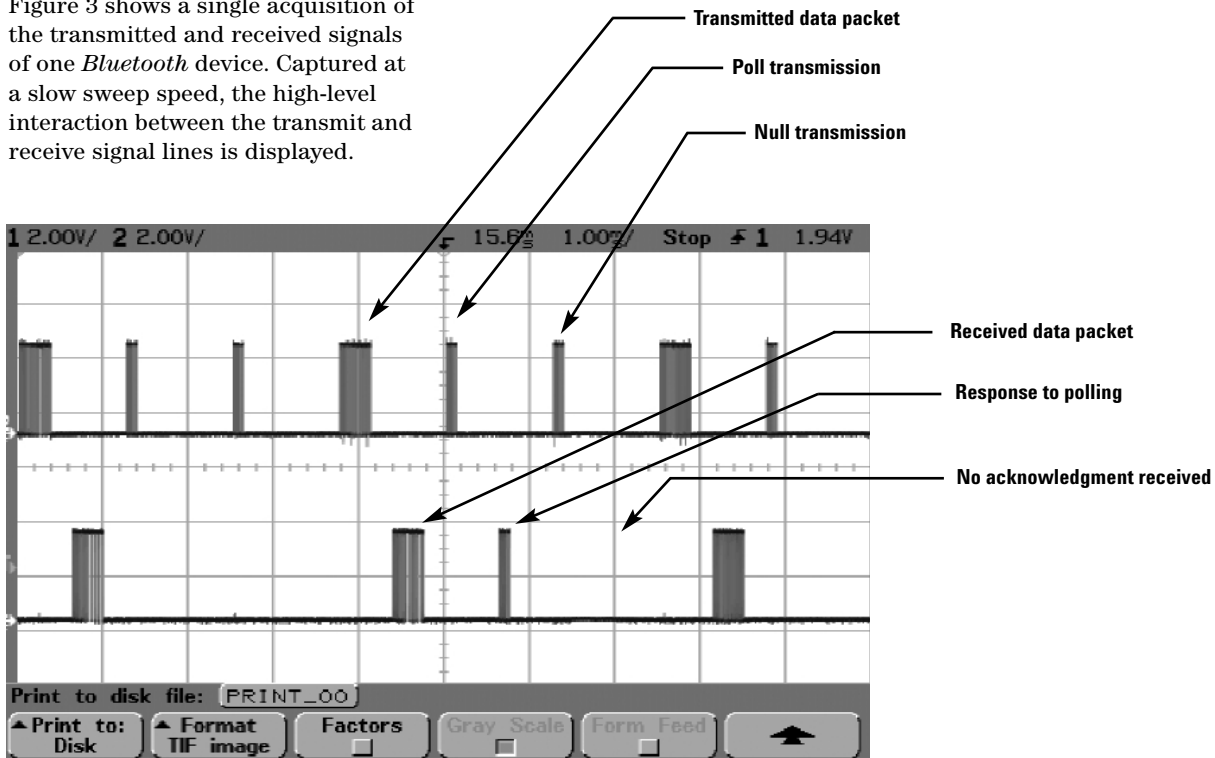

Figure 3: Transmit and receive high-level view

Using deep memory and Agilent's MegaZoom technology, the transmitted data packet from Figure 3 can be examined in fine detail without re-triggering. Figure 4 shows the initial signal transitions, which were captured at a time base setting of 1.00 ms/division now, zoomed to 5.00  $\mu$ s/division. Often, intermittent anomalies may be captured in a big-picture view, but when the signal is re-captured, the anomaly is no longer present. The ability to trigger one time with deep memory allows a large time capture where signal behavior can be viewed later in detail using the same initial data.

A packet is a single bundle of information transmitted within a piconet. A packet is transmitted on a frequency hop and nominally covers a single time slot, but may be extended to cover up to five time slots.

The first two pulses shown in Figure 4 correspond to the *Bluetooth* packet preamble consisting of a fixed zero-one pattern of four binary symbols. The Preamble is the first part of the packet access code. Immediately following the Preamble is a pattern of ones and zeros comprising the Sync Word (see Figure 5).

Since the Preamble is predefined, the bit size can be determined by inspection (see Figure 4). Once this is known, the entire bit stream encompassing the access code, header, and payload can be identified on a bit-by-bit basis. Agilent's MegaZoom technology lets designers view the high-level transactions to verify that the operation is correct and lets users pan and zoom through the entire data packet to verify specific bit stream data values.

If two *Bluetooth* devices are configured as shown in Figure 2, a variation to the measurement in Figure 3 would be to use four channels to probe the transmit and receive signals of both Device A and Device B simultaneously. This lets designers pan and zoom through the

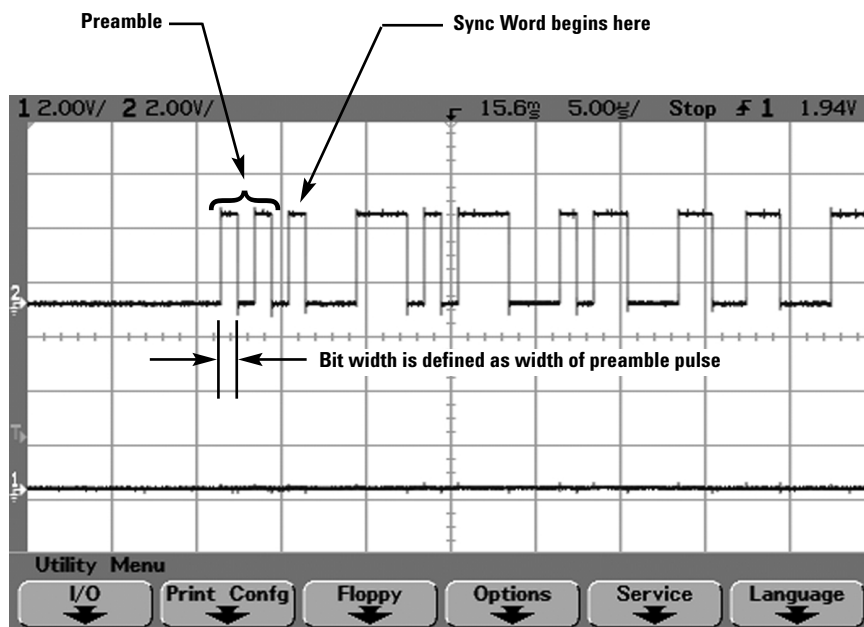

Figure 4: Transmitted data packet zoomed view

acquisition to view correlated waveform activity between the two *Bluetooth* devices. This is useful, for example, to verify that an SCO (Synchronous Connection Oriented) link between *Bluetooth* applications is functioning. An SCO link is a direct, dedicated bandwidth connection for use with time-critical applications such as voice. This verification can identify connectivity errors when integrating two *Bluetooth* devices into one system.

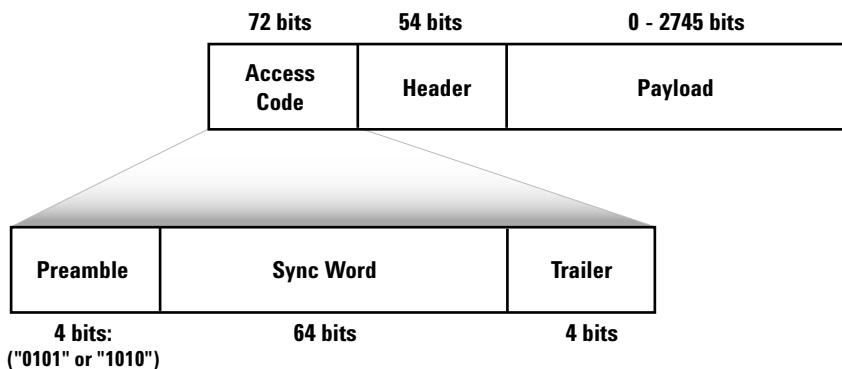

Figure 5: *Bluetooth* packet structure specification

## UART Transport Layer Delay

Transferring a file between two applications is a common operation performed by *Bluetooth* devices. The UART (Universal Asynchronous Receiver-Transmitter) is one of two HCI (Host Controller Interface) transport layers specified for serial communication between *Bluetooth* devices. In Figure 6, the Master host is a laptop computer and the Slave host is another laptop computer. As the Master transmits a text file piecewise in HCI packets, the UART interface is not able to keep pace with the transmit and receive lines. At this slow sweep speed, we see a segment of UART inactivity. Meanwhile, the Master continues to resend data packets until the UART catches up.

By definition, the length of each time slot is 625  $\mu$ s. The cursor measurements in Figure 6 show a value of 2.40 ms, which corresponds to the Master occupying 4 time slots.

Based on this high-level screen capture capability, the design engineer can verify that the constraint is not the *Bluetooth* device. This is evident in Figure 6, which shows the Master device continuing to re-transmit data (scope channel D0) while the UART transmit line (scope channel D1) is inactive.

This graphical image identifies the source of the data bottleneck as the relatively slow UART capabilities of the laptop computer. Another on-screen measurement would be to measure the amount of time needed for information to transfer from the sending application to the receiving application, in order to estimate and benchmark system performance.

Using MegaZoom technology, engineers can zoom in on the packet transfer to the bit stream level and verify actual file data. With one long time segment captured in scope memory, each transition sequence of ones and zeroes can be matched with the binary values of an ASCII table to uniquely identify the transmission of each alphanumeric file character.

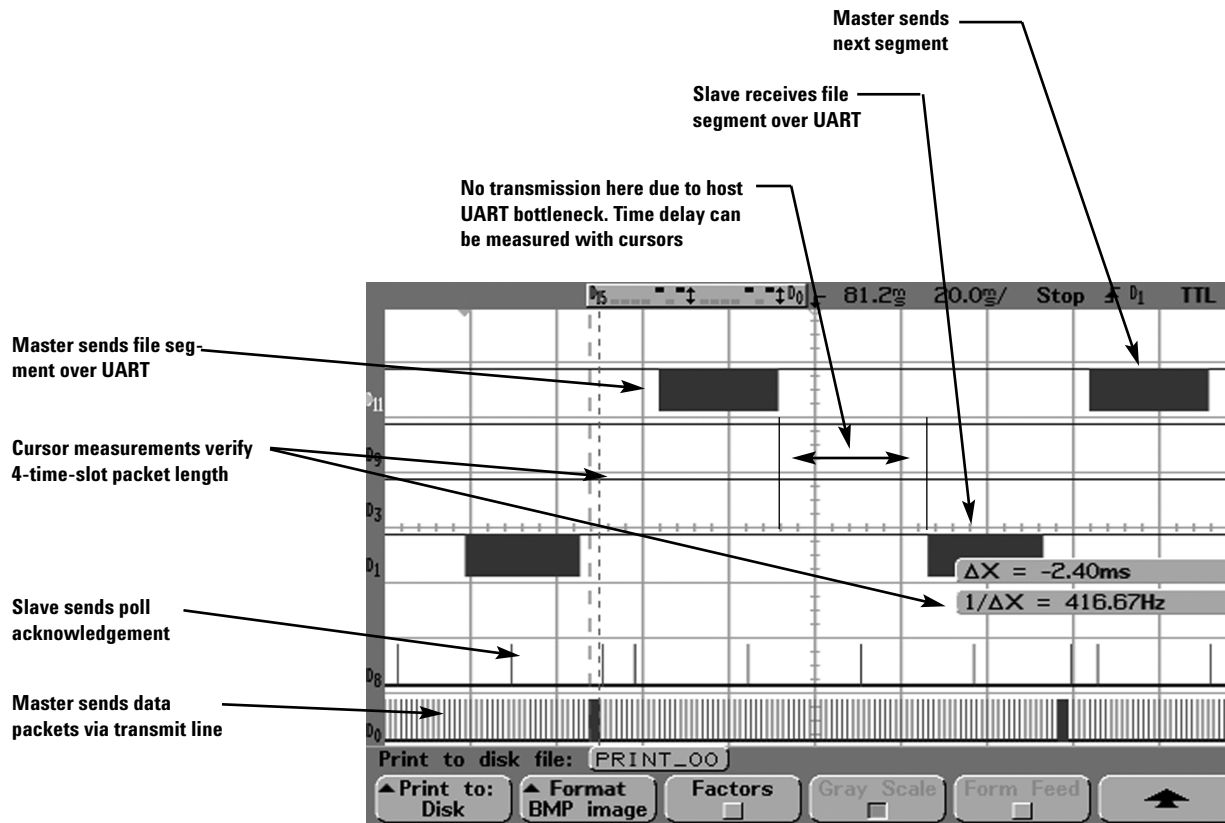

Figure 6: Master transfers file over UART

## Reversing File Transfer Direction

In reversing the file transfer direction from the previous example, Figure 7 shows a zoomed image of the Slave transmitting a file and the Master receiving the file. Because a device in Slave mode only responds when contacted by the Master device, the Master transmits Null packets continuously, allowing the Slave to respond.

From the time base range on screen, you can see that the Slave is transmitting the file data in one-time-slot packets.

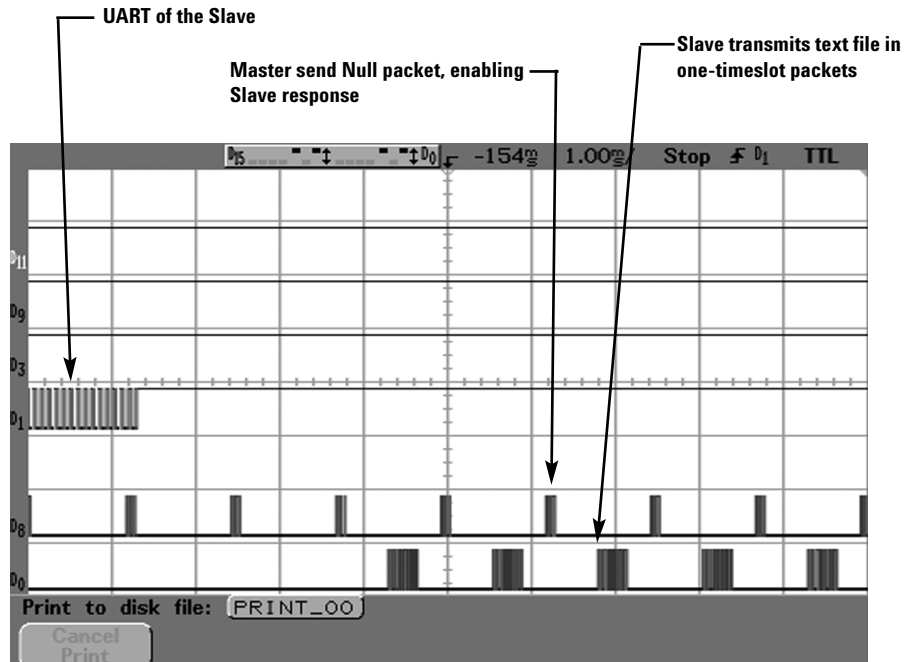

Figure 7: File transmission from the Slave

## Identifying A Logic Error

In the scenario shown in Figure 8, the Master device sends a train of pages to the Slave, repeatedly addressing it by its unique identifier. After a response is attained, the Master begins transmitting data but gets no response. Another page by the Master results in a response from the Slave, but again data is not acknowledged and the pattern is repeated.

Combined with the previous hardware tests, this high-level verification feature enables the design engineer, by process of elimination, to isolate the peculiar behavior to an actual software logic error in the host device.

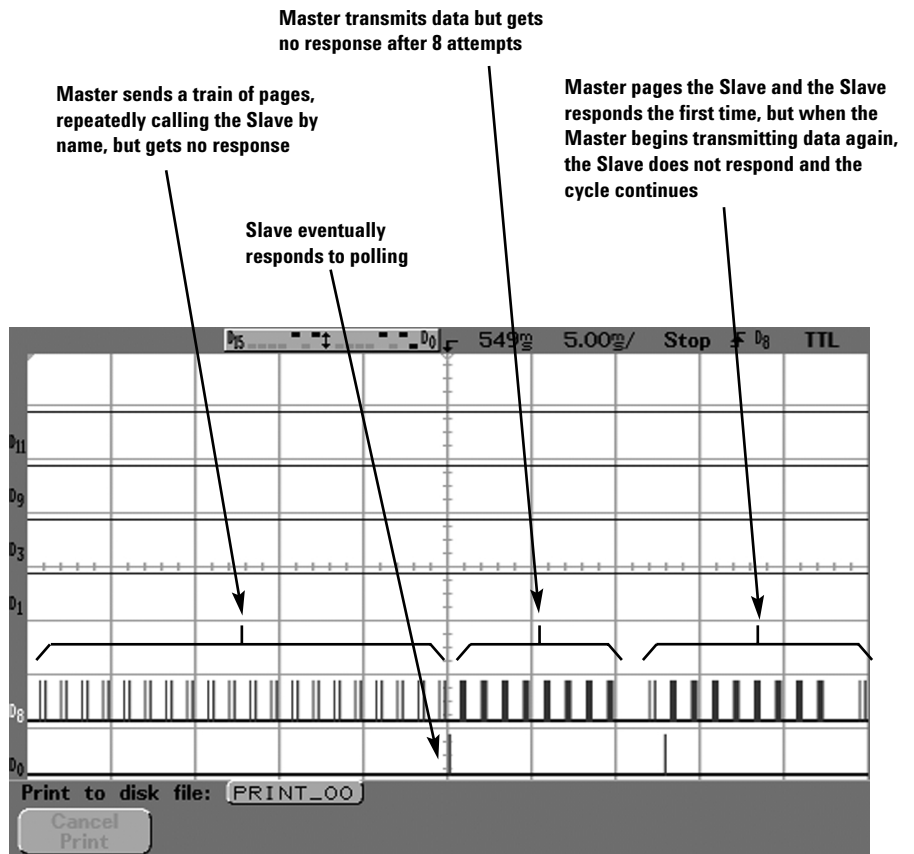

Figure 8: Software logic error occurs

## Mixed Signal Designs

Mixed analog and digital designs are the foundation of today's wireless technology. For simplicity, the examples chosen above only involved the discussion of using two or four channels. In addition to viewing the transmit and receive signals of both devices and probing the UART signals at each interface, important information can be added by including the input and output signals from the A/D and D/A converters on the baseband, and measuring the power supply, clocks, reset, and memory bus values. Corresponding signals of multiple devices in a piconet could be measured simultaneously as well. MegaZoom technology allows the capture of high-level information and the ability to zoom in on each signal to measure rise and fall times, preshoot, overshoot, ringing, noise effects, ground bounce, and many other phenomenon while simultaneously providing the high-level view of the overall baseband operation.

## Conclusion

*Bluetooth* is a powerful and versatile technology, which allows instant wireless connectivity between personal information devices including wireless handsets, personal digital assistants, computers, printers and many other information appliances.

Our discussion has outlined techniques for debugging *Bluetooth* baseband system-level interaction. Specific techniques and measurement hints were highlighted, including the verification of transmission and receipt of data packets, viewing the actual data values transmitted, quantifying system bottlenecks, and identifying logic errors. As *Bluetooth* chipsets are being rapidly integrated into a multitude of consumer and wireless devices, the functions and measurements illustrated will result in providing valuable and accurate information to the design engineer as well as producing time-to-market savings for customers implementing these *Bluetooth* products. Working with Texas Instruments' engineering team and its advanced *Bluetooth* chipset, we have been able to demonstrate and document some of the key measurements important to the design engineer.

For more information about Texas Instruments' *Bluetooth* solutions, please visit [www.ti.com/sc/bluetooth](http://www.ti.com/sc/bluetooth).

Information about *Bluetooth* solutions from Agilent Technologies can be found at [www.agilent.com/find/bluetooth](http://www.agilent.com/find/bluetooth)

## Related Literature:

<i>Agilent Technologies 54620-Series Oscilloscopes</i> , product overview	5968-8142EN
<i>Agilent Technologies 54620-Series Probes and Accessories</i> , product overview	5968-8153EN
<b>Bluetooth™</b> RF Measurements Fundamentals, Agilent Application note 1333-1	5988-3760EN
<i>Agilent Technologies Bluetooth Solutions</i> Brochure	5980-3032EN

### Agilent Technologies' Test and Measurement Support, Services, and Assistance

Agilent Technologies aims to maximize the value you receive, while minimizing your risk and problems. We strive to ensure that you get the test and measurement capabilities you paid for and obtain the support you need. Our extensive support resources and services can help you choose the right Agilent products for your applications and apply them successfully. Every instrument and system we sell has a global warranty. Support is available for at least five years beyond the production life of the product. Two concepts underlie Agilent's overall support policy: "Our Promise" and "Your Advantage."

#### Our Promise

Our Promise means your Agilent test and measurement equipment will meet its advertised performance and functionality. When you are choosing new equipment, we will help you with product information, including realistic performance specifications and practical recommendations from experienced test engineers. When you use Agilent equipment, we can verify that it works properly, help with product operation, and provide basic measurement assistance for the use of specified capabilities, at no extra cost upon request. Many self-help tools are available.

#### Your Advantage

Your Advantage means that Agilent offers a wide range of additional expert test and measurement services, which you can purchase according to your unique technical and business needs. Solve problems efficiently and gain a competitive edge by contracting with us for calibration, extra-cost upgrades, out-of-warranty repairs, and on-site education and training, as well as design, system integration, project management, and other professional engineering services. Experienced Agilent engineers and technicians worldwide can help you maximize your productivity, optimize the return on investment of your Agilent instruments and systems, and obtain dependable measurement accuracy for the life of those products.



### Agilent Email Updates

[www.agilent.com/find/emailupdates](http://www.agilent.com/find/emailupdates)

Get the latest information on the products and applications you select.



### Agilent Direct

[www.agilent.com/find/agilentdirect](http://www.agilent.com/find/agilentdirect)

Quickly choose and use your test equipment solutions with confidence.

### Agilent T&M Software and Connectivity

Agilent's Test and Measurement software and connectivity products, solutions and developer network allows you to take time out of connecting your instruments to your computer with tools based on PC standards, so you can focus on your tasks, not on your connections. Visit [www.agilent.com/find/connectivity](http://www.agilent.com/find/connectivity) for more information.

**By internet, phone, or fax, get assistance with all your test & measurement needs**

#### Phone or Fax

##### United States:

(tel) 800 829 4444

##### Canada:

(tel) 877 894 4414

(fax) 905 282 6495

##### China:

(tel) 800 810 0189

(fax) 800 820 2816

##### Europe:

(tel) (31 20) 547 2323

(fax) (31 20) 547 2390

##### Japan:

(tel) (81) 426 56 7832

(fax) (81) 426 56 7840

##### Korea:

(tel) (82 2) 2004 5004

(fax) (82 2) 2004 5115

##### Latin America:

(tel) (305) 269 7500

(fax) (305) 269 7599

##### Taiwan:

(tel) 0800 047 866

(fax) 0800 286 331

##### Other Asia Pacific Countries:

(tel) (65) 6375 8100

(fax) (65) 6836 0252

Email: [tm\\_asia@agilent.com](mailto:tm_asia@agilent.com)

##### Online Assistance:

[www.agilent.com/find/assist](http://www.agilent.com/find/assist)

Product specifications and descriptions in this document subject to change without notice.

© Agilent Technologies, Inc. 2004

Printed in USA,

March 5, 2004

**5988-2181EN**



**Agilent Technologies**